

série RICO

QS308, QS309, QS1080, QS1280

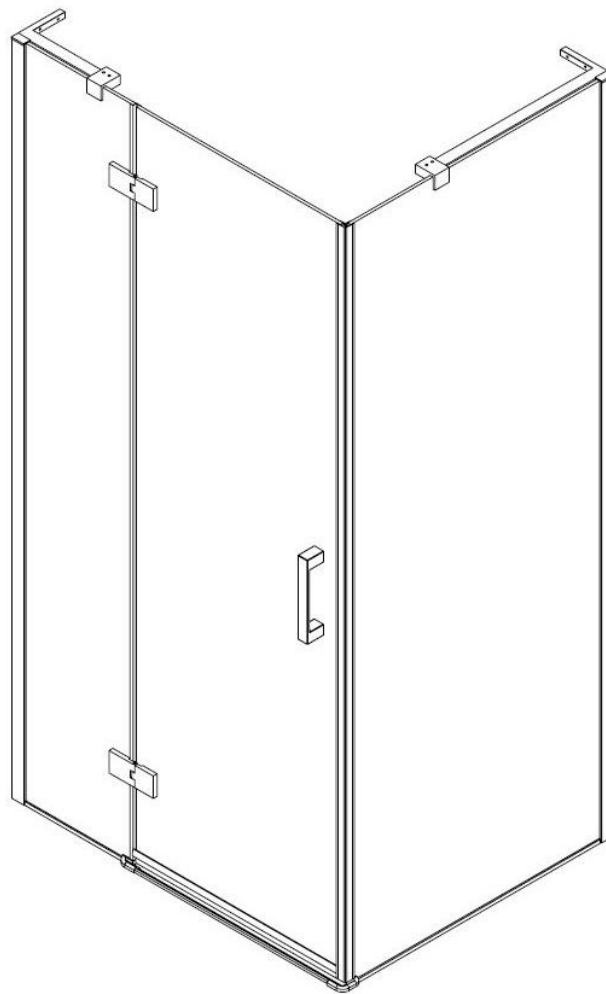

■ Obecné informace

Prosíme zkontrolujete produkt ihned po převzetí pro případ poškození přepravou, chybějící díly nebo výrobní vady. Na reklamace tohoto typu nebude později brán zřetel. prosíme zacházejte se zbožím opatrně a vyhněte se jakýmkoliv nárazům nebo šokům na všech hranách skla.

Poznámka: Bezpečnostní kalené sklo, nelze řezat/upravovat.

■ Instalace

Prosíme o pečlivé přečtení těchto instrukcí před začátkem montáže.

Kotvicí lišta má vůli až 20mm pro situace kde zeď nemá přesný rozměr.

Ujistěte se, že je vanička v rovině a po smontování koutu je mezi vaničkou a sprchovým koutem nepřerušená linie silikonu.

Věnujte zvýšenou pozornost při navrtávání do zdi aby jste nenarazili na elektrické vedení nebo potrubí.

Poznámka: Tento produkt je velmi těžký a na jeho montáž jsou potřeba dva lidé.

Prosíme odstraňte před montáží ochranné folie z hliníkových profilů.

■ Instalace sprchové vaničky

Sprchová vanička musí být položena u nosné zdi.

Vodotěsné opatření nebo spádování by mělo být instalováno tak aby bylo položeno na okraji vaničky.

■ Údržba

Po použití by měl být sprchová kout vyčištěn pomocí mýdlové vody, toto je důležité hlavně v oblastech s tvrdou vodou kde mají vápenné soli možnost se nahromadit a usazovat. Hrubé čističe nebo čističe s pevnými částicemi by neměli být používány. Pečujte o to aby se předešlo kontaktu se silnými chemikáliemi jako například organické rozpouštědla.

Čističe skel použijte s opatrností, pokud máte pochybnosti, kontaktujte dodavatele čističe.

Prosíme dodržujte tyto instrukce pro údržbu.

Potřebné nářadí

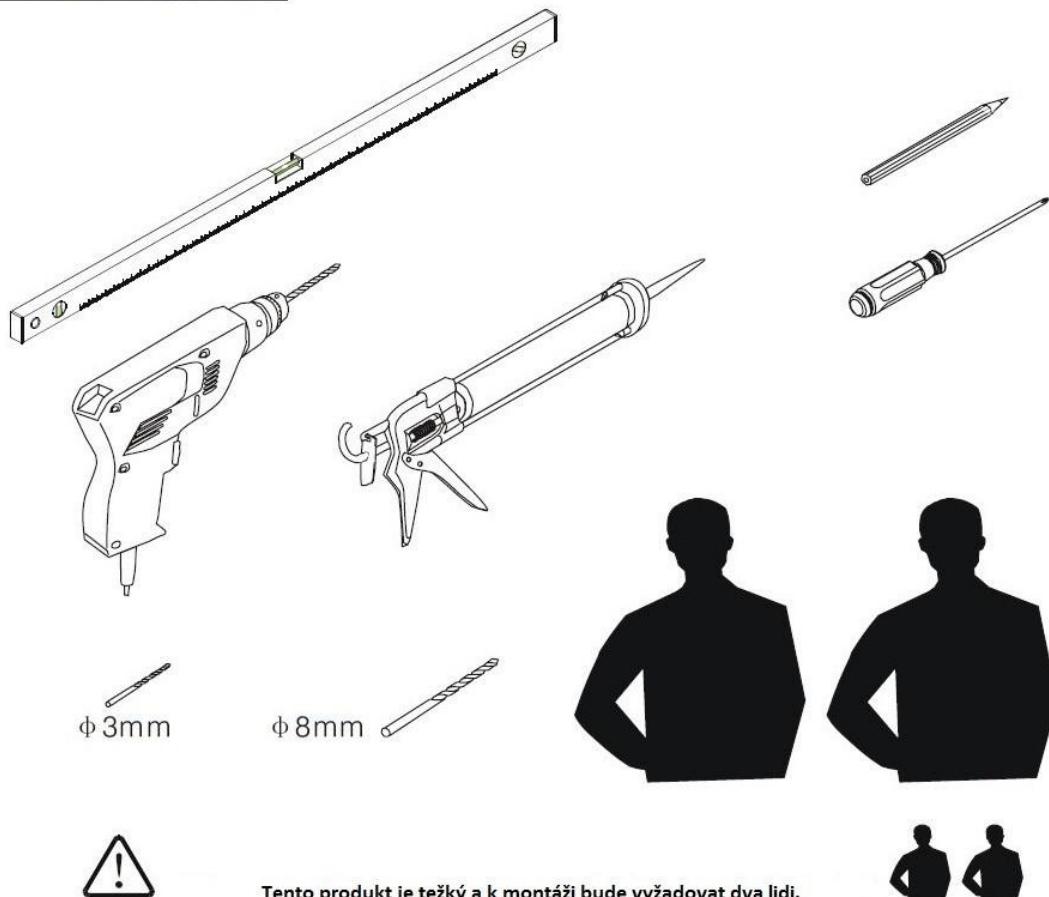

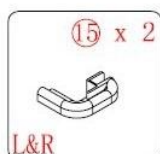
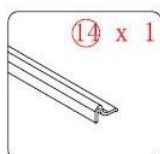
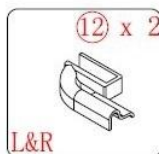
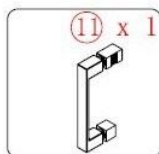
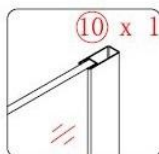
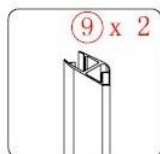
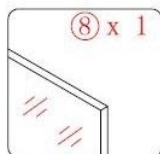
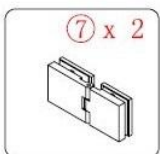
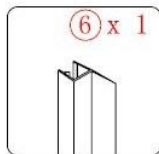
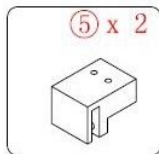
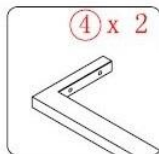
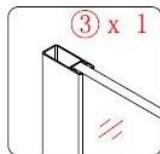
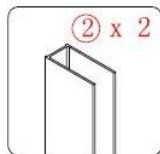
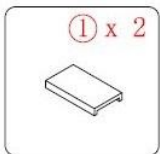
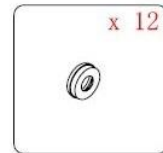
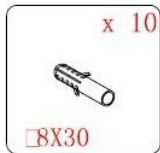
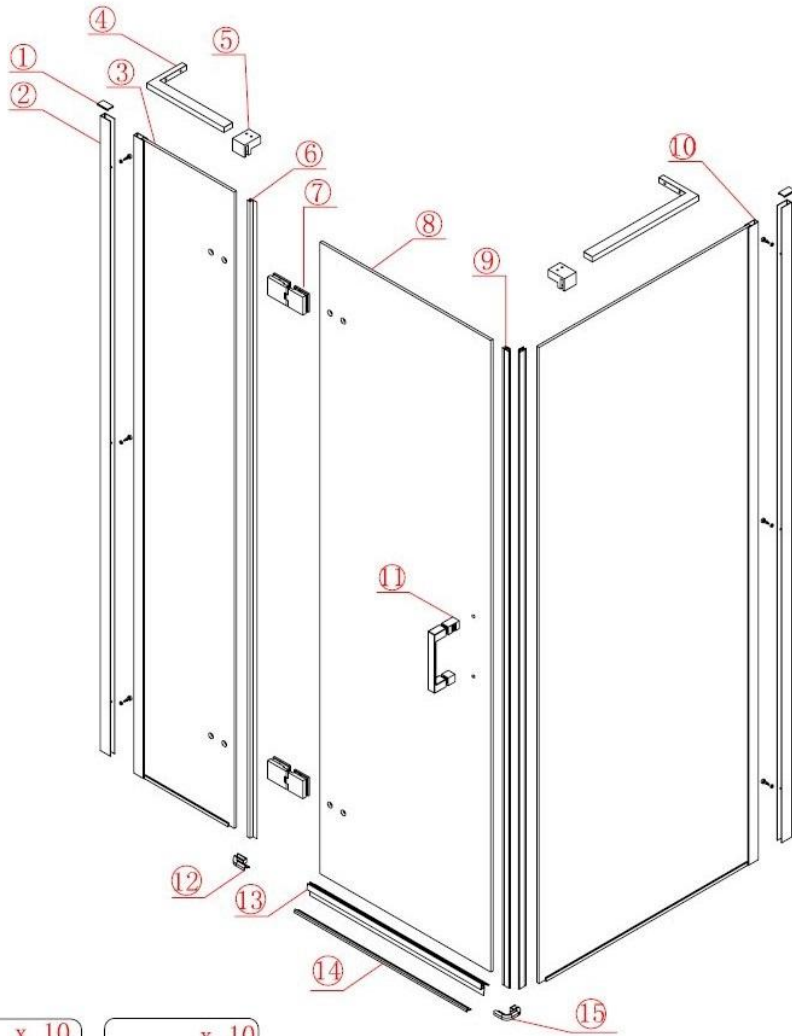

Tento produkt je těžký a k montáži bude vyžadovat dva lidi.



754 (QS308), 854 (QS309),
954 (QS1080), 1154
(QS1280)

862 (QS309)
762 (QS308, QS1080,
QS1280)

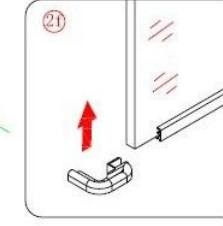
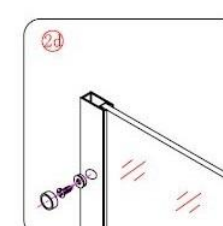
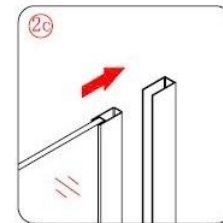
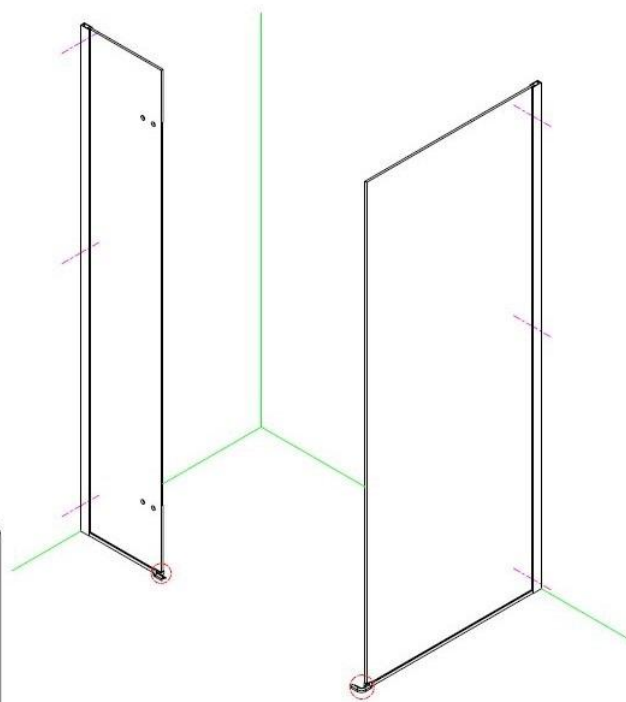
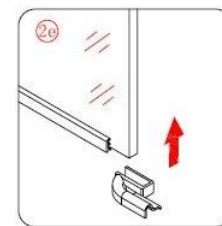
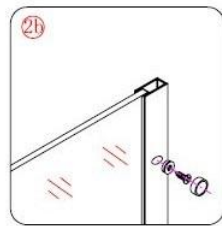
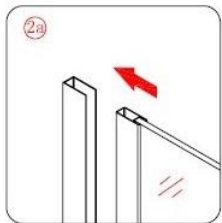
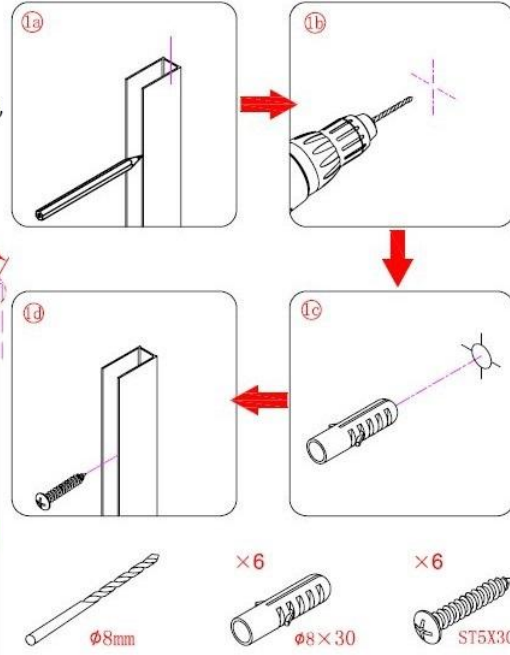
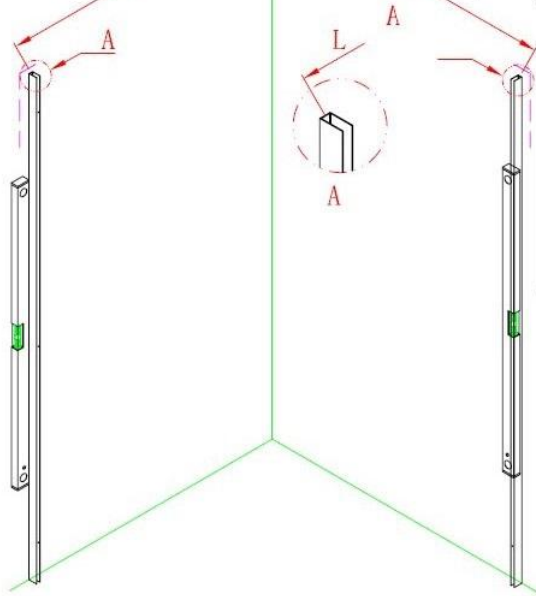

Tento produkt je těžký a bude montáž bude vyžadovat dva lidi.



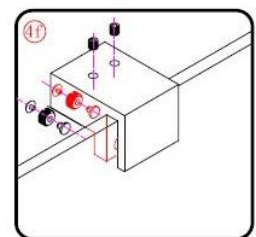
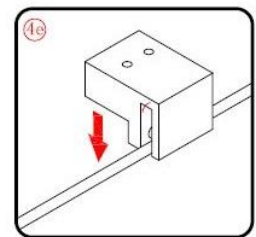
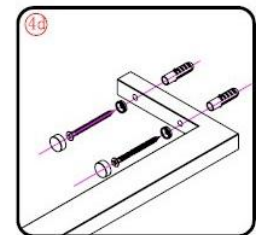
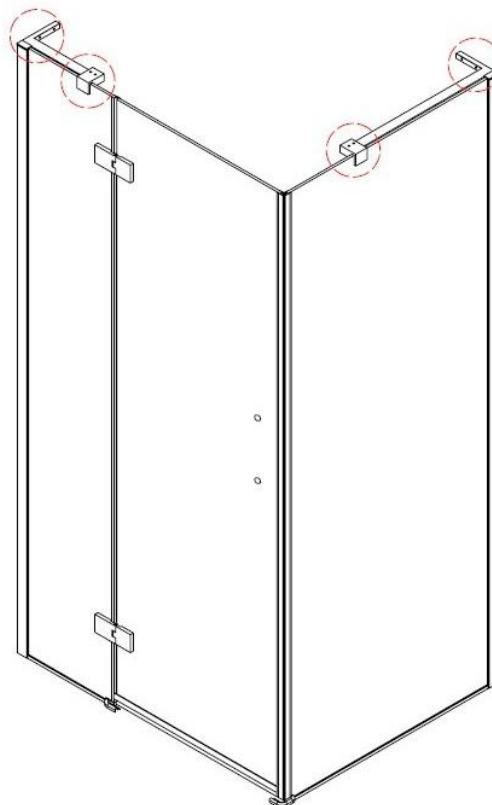
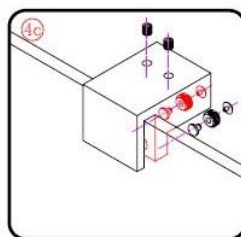
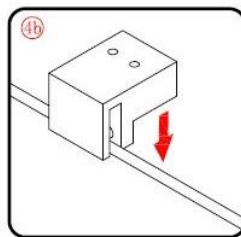
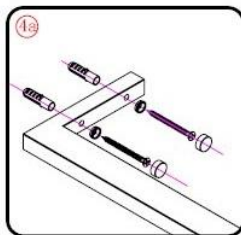
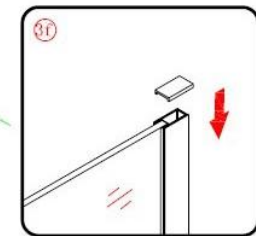
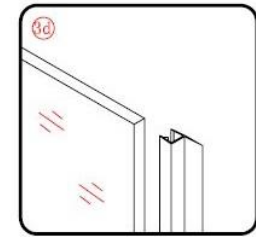
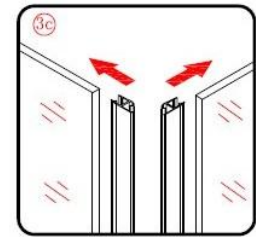
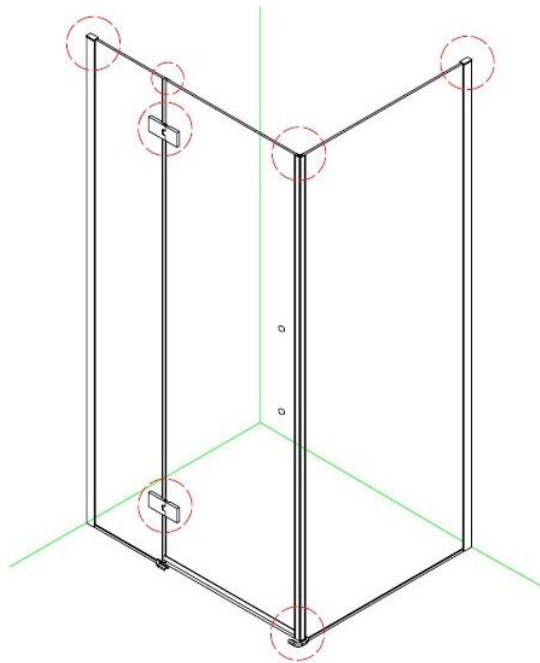
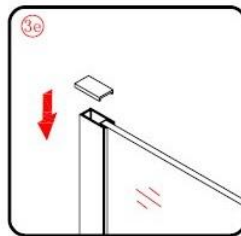
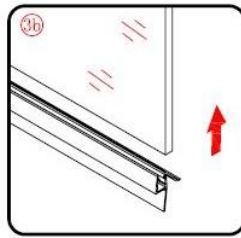
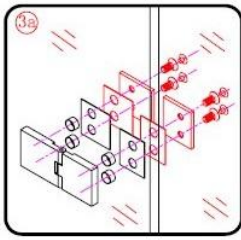

Tento produkt je těžký a montáž bude vyžadovat dva lidi.



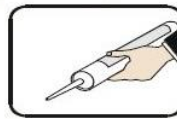
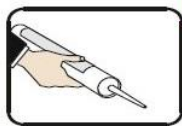
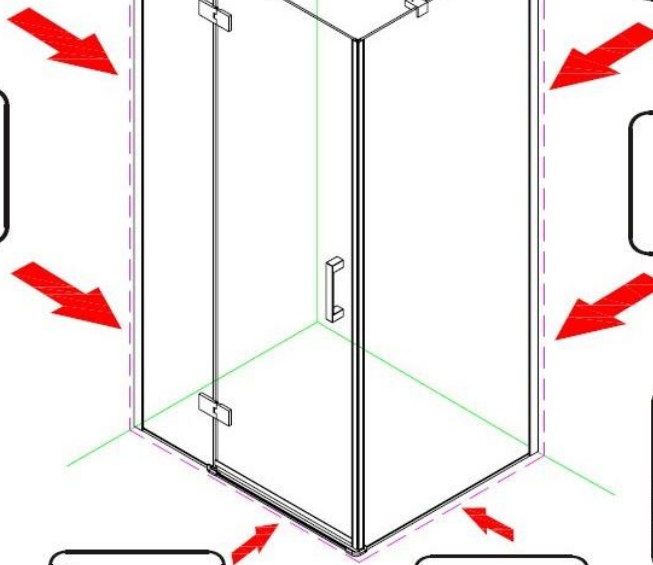
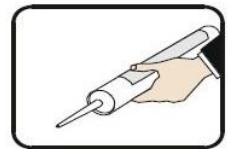
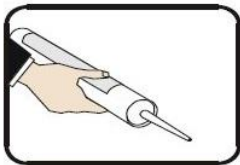
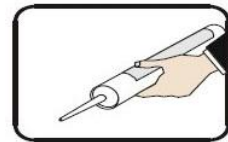
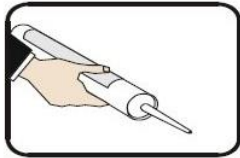
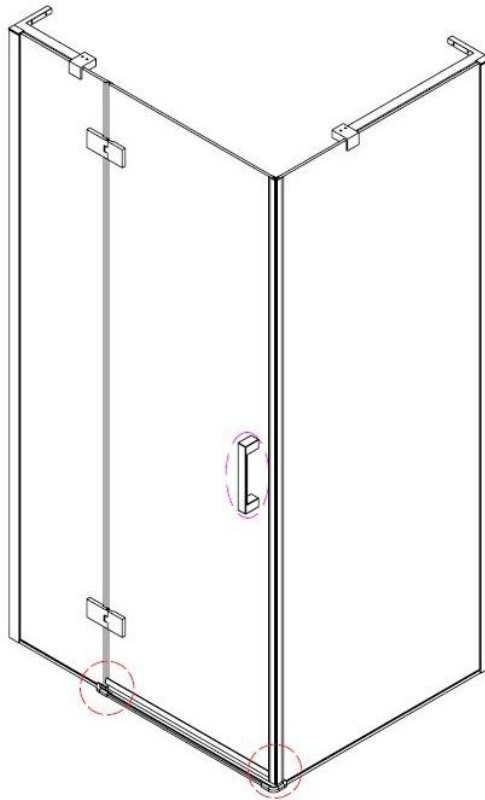
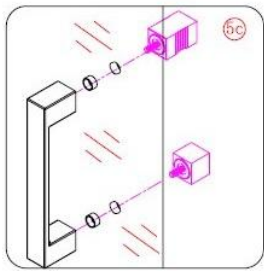
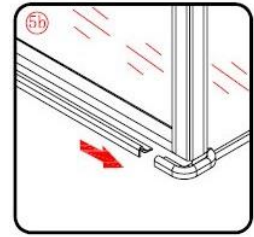
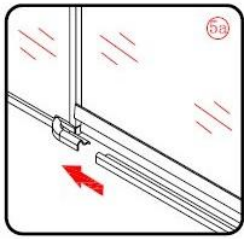

Tento produkt je těžký a jeho montáž vyžaduje dva lidi.

